

Cômoda 3 Gavetas

Linha bo.



Observações gerais

Pessoas Necessárias para montagem



2 pessoa

IMPORTANTE

As gavetas devem ser abertas apenas uma de cada vez, pois o sistema de corrediças telescópicas usado é de extração total das gavetas. Abrindo mais de uma gaveta simultaneamente o centro de gravidade da cômoda pode deslocar-se para frente e ocorrer o tombamento da mesma!

Ferramentas Necessárias (Não Fornecidas)

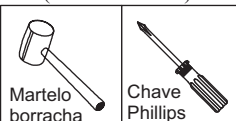

Martelo borracha

Chave Phillips

ATENÇÃO

- 1- Ler e observar atentamente toda a instrução antes de iniciar a montagem.
- 2- A montagem do produto deverá ser feita em uma superfície limpa e plana. Aconselhamos utilizar a embalagem para forrar o chão a fim de não danificar o produto.
- 3- Os parafusos devem ser apertados periodicamente.
- 4- Evitar batidas e o contato com objetos cortantes.

LIMPEZA

- 1- Usar pano levemente umedecido com água seguido de pano seco.
- 2- Não utilizar produtos químicos ou abrasivos.

ciadomóvel

Dúvidas e Sugestões: www.ciadomovel.com.br

Partes do Produto

- 1 - Tampo (1x)
- 2 - Base (1x)
- 3 - Lateral (2x)
- 4 - Frente Gaveta (3x)
- 5 - Gaveta (3x)
- 6 - Fundo (3x)
- 7 - Travessa do Pé (2x)
- 8 - Pé (2x)
- 9 - Fundo de Gaveta (3x)

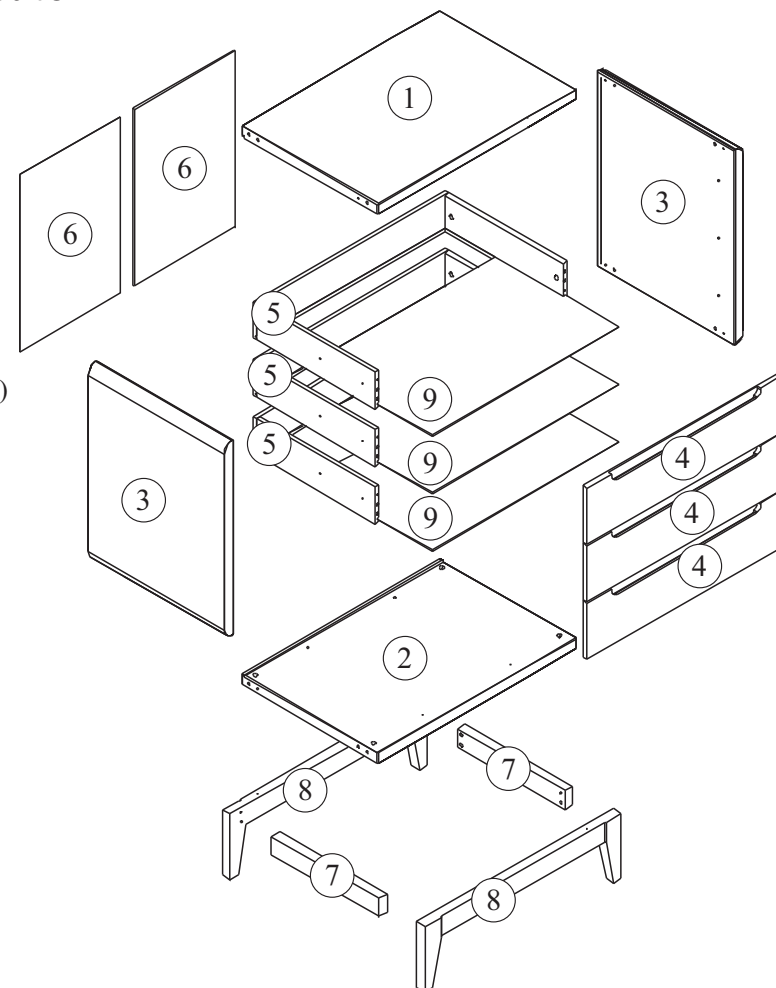

Componentes

A	14X	B	14X	C	6X	D	3X	E	8X	F	4X	G	46X
TAMBOR MINIFIX		PARAFUSO MINIFIX		ADESIVO Ø18		CORREDIÇA 450 TELESCOPIO		PF AA CAB CH PH Ø4,5X30		PF AA CAB CH PH Ø5X50		PF AA CAB CH PH Ø4X14	
H	14X	I	16X	J	8X	L	1X	M	1X	S	4X		
CAVILHA Ø8X30		TRAVA P/ FUNDOS		TRAPÉZIO		MATA JUNTA H 12X610		COLA		FELTRO Ø25			

1 Pré Montagem

Desmontando as Corrediças

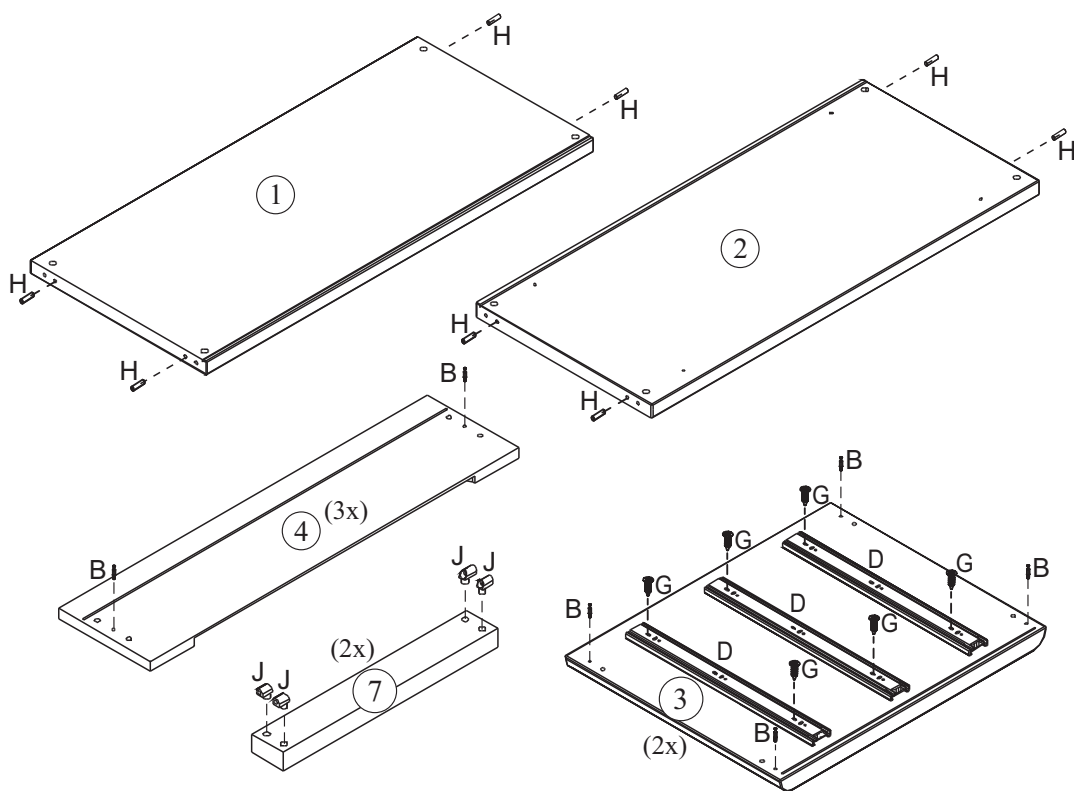
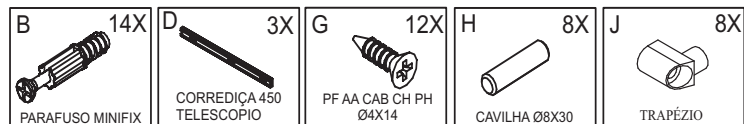
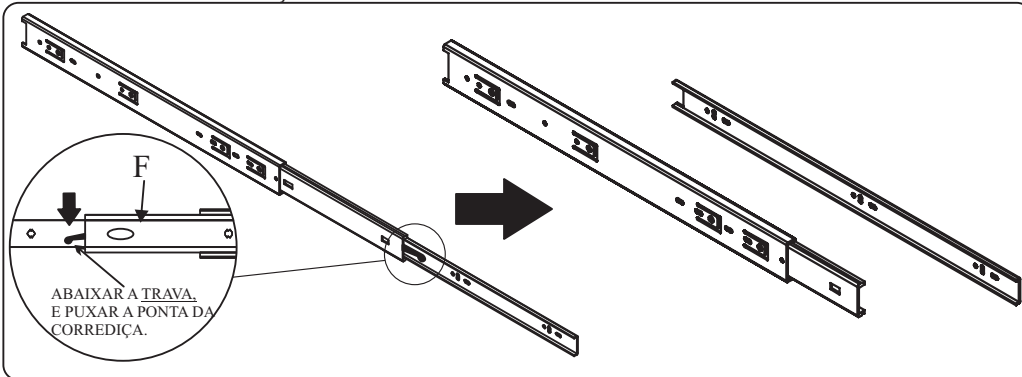

1 Montagem

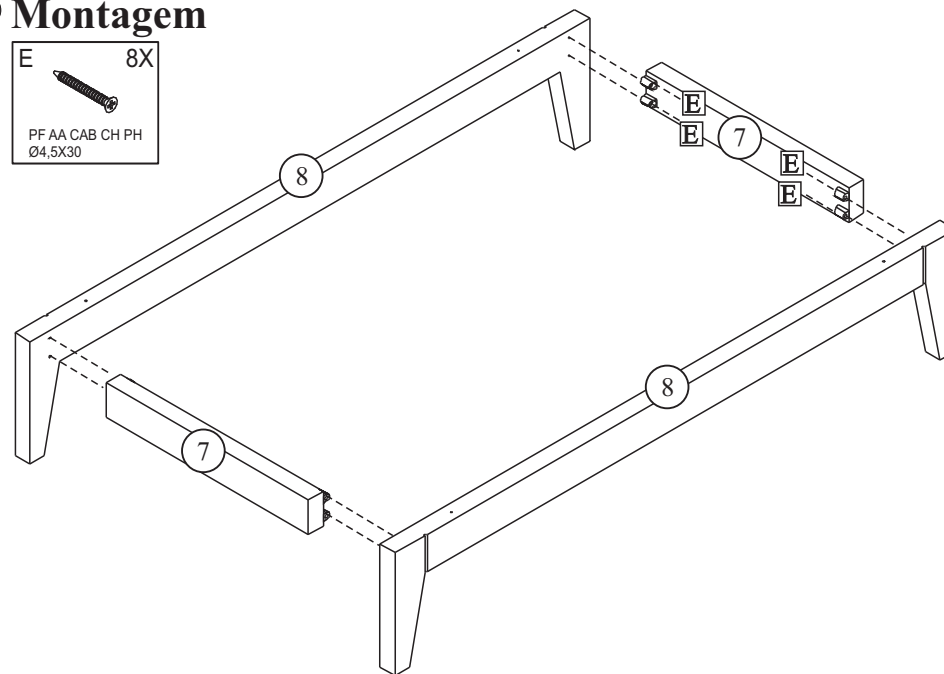
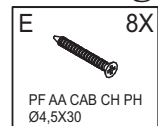

1 Montagem das Gavetas

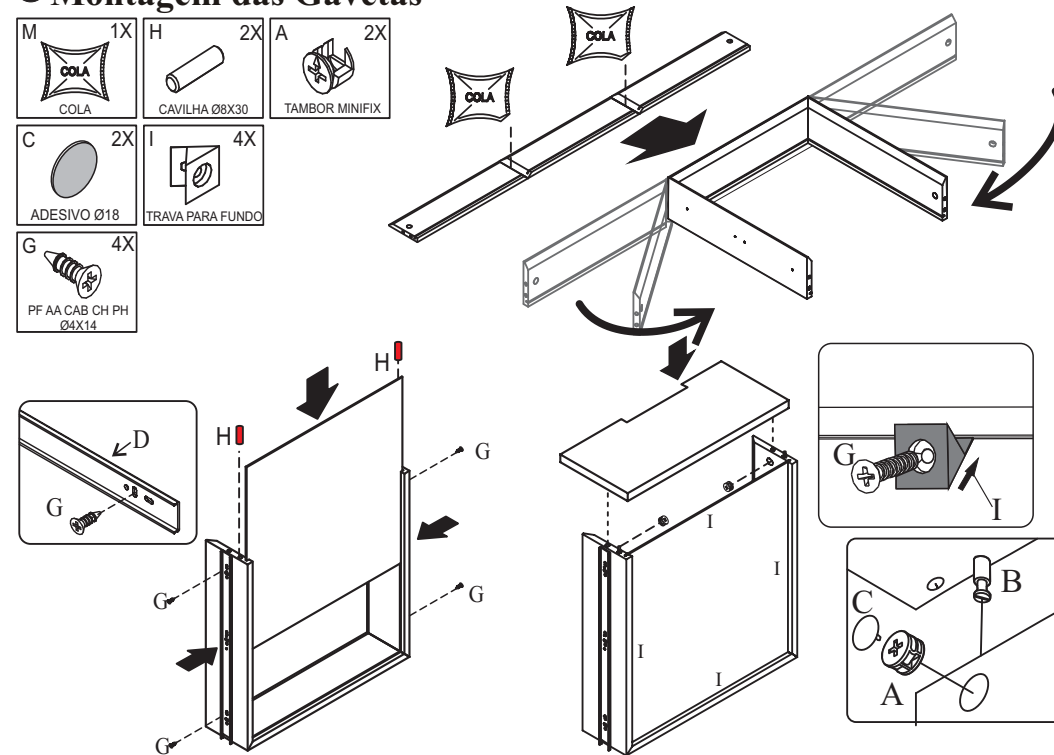
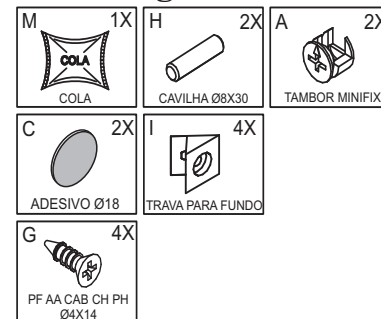

2 Montagem

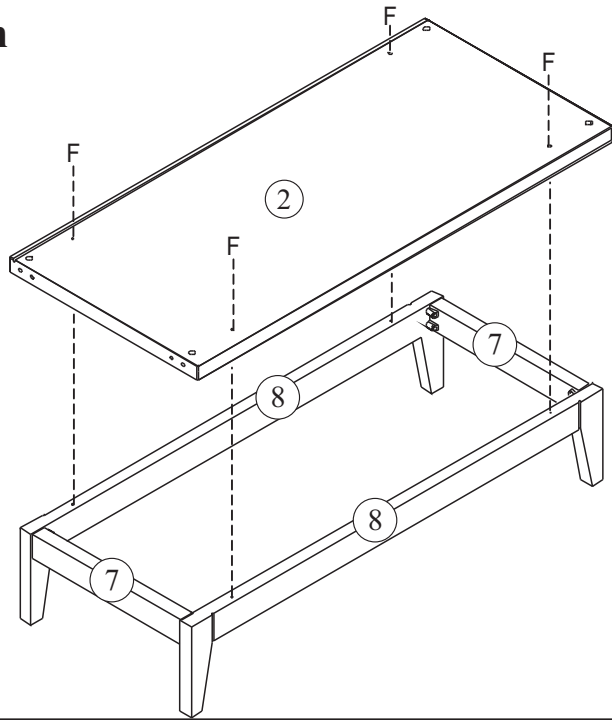
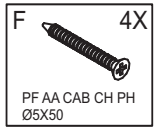

4 Montagem

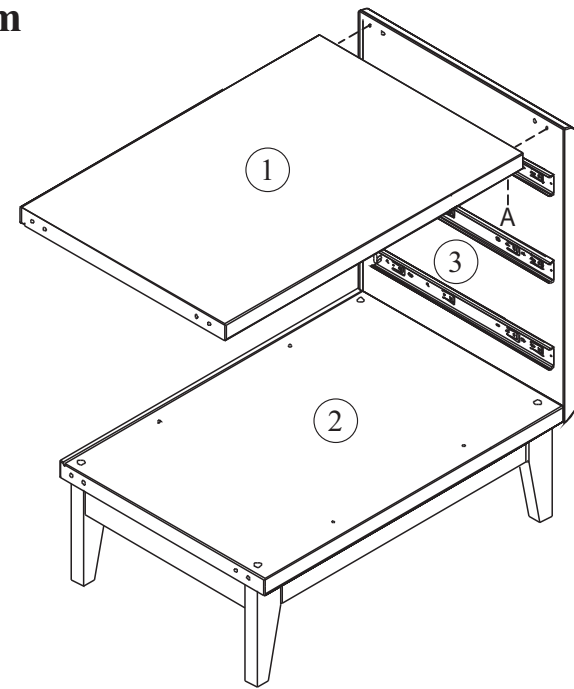
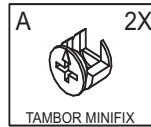

3 Montagem

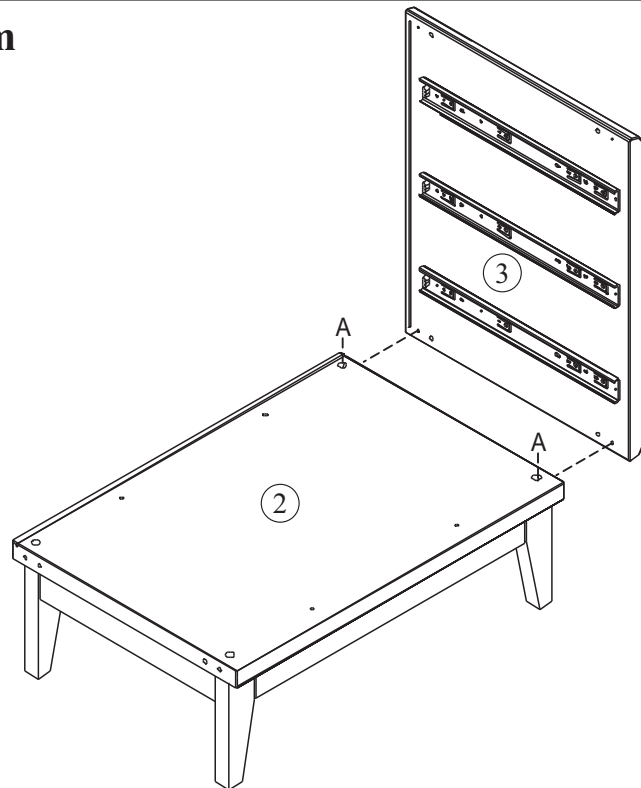
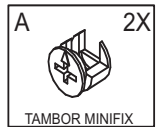

5 Montagem

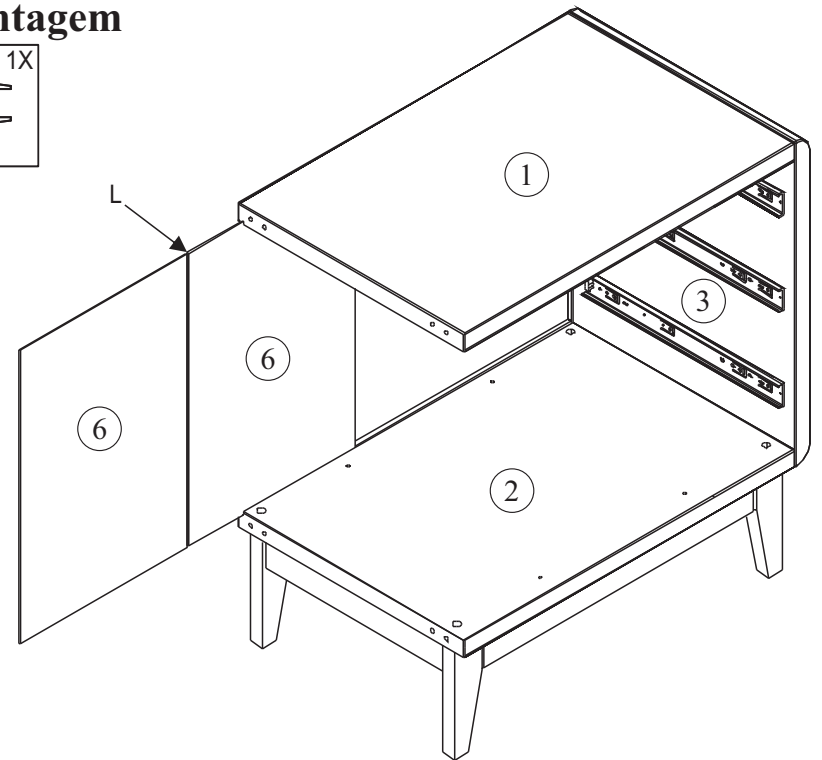
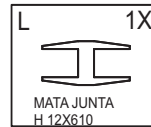

6 Montagem

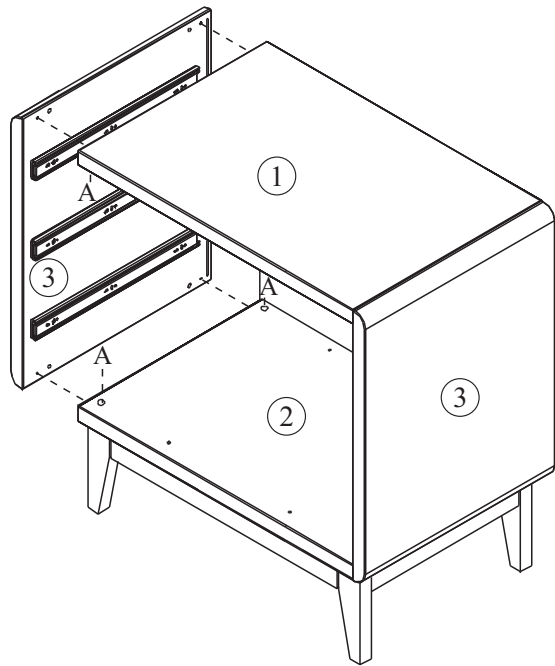
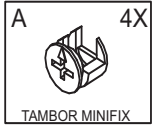

7 Montagem

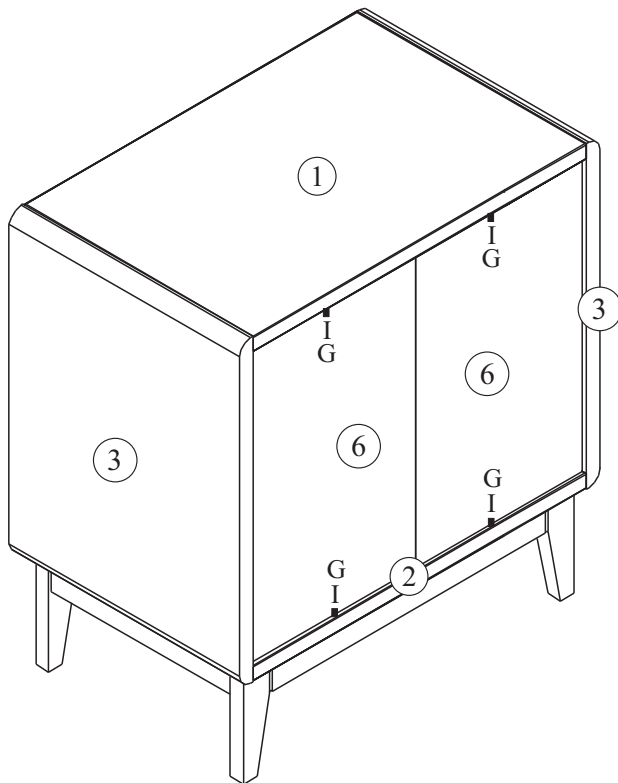
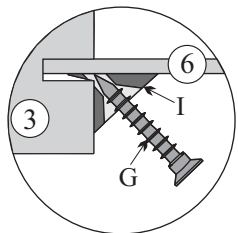
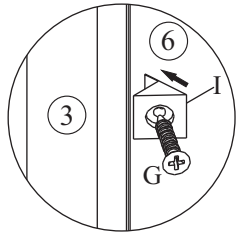
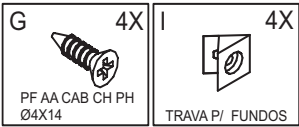

- Carga Máxima Uniformemente Distribuída

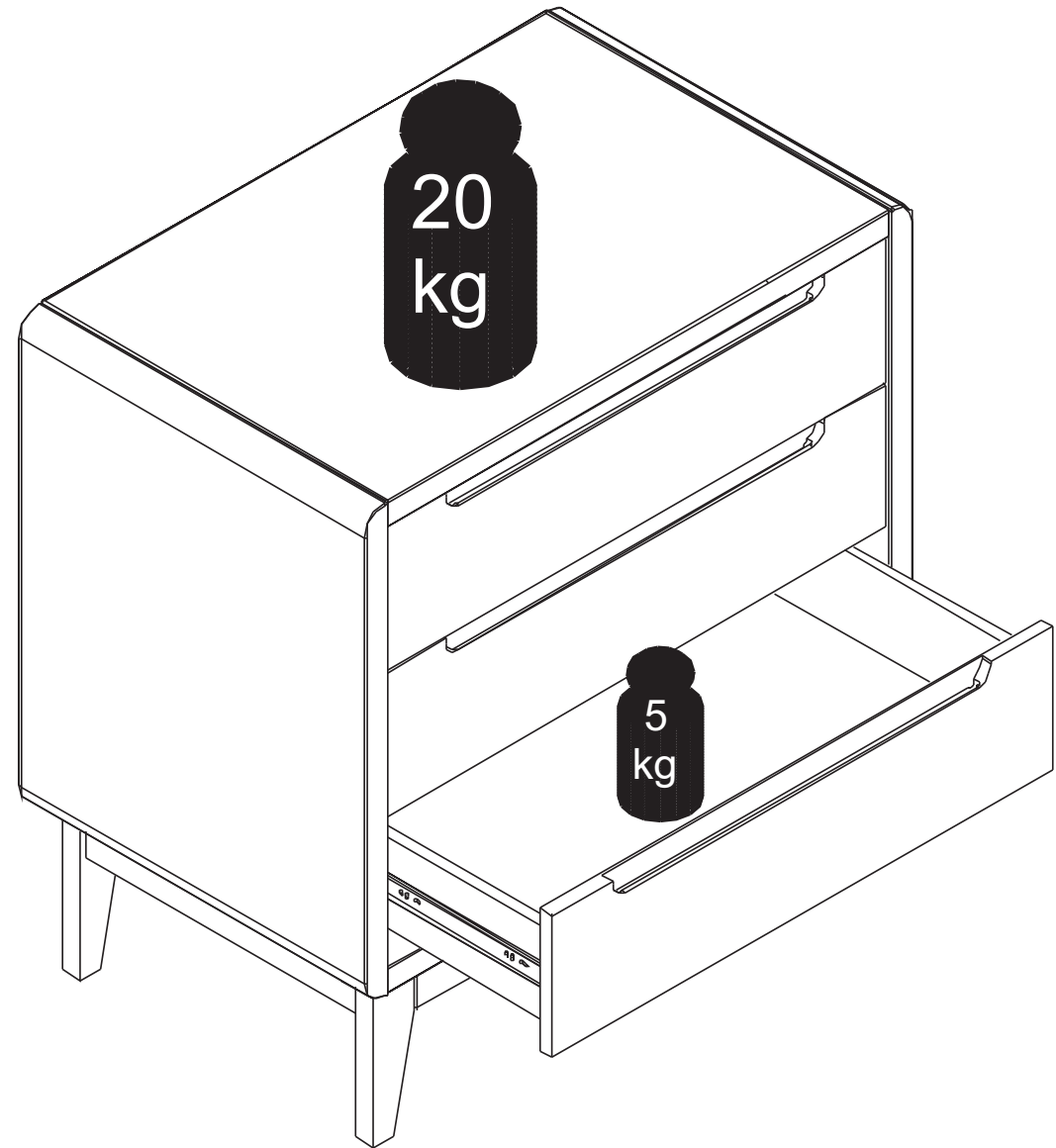

- Carga Máxima suportada do produto,
conforme indicação na imagem:
- 5 kg por Gaveta;
- 20 kg na Cômoda.