

ABRA, CHEGOU!

ABRA
c a s a

CAMA AUXILIAR SAMUCA

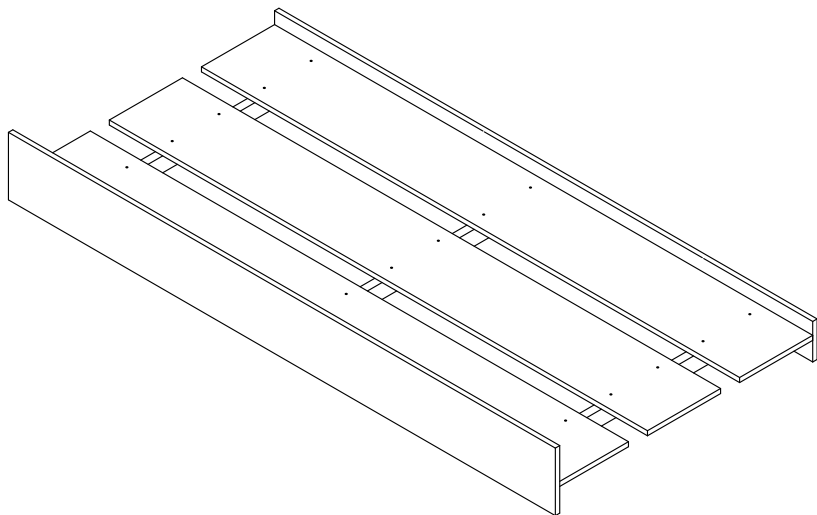

ferramentas, **não fornecidas**, que são necessárias para a montagem:



parafusadeira para chave phillips e ponteira allen

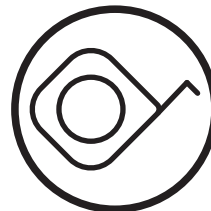

trena

Atenção! Este produto possui partes de madeira natural e/ou lâminas naturais de madeira. Por essa razão pode apresentar variações de tonalidade e de padrões de veios, tanto entre as peças e partes do produto, como de produtos de mostruários e de fotos de catálogos e site.

Cuidados:



Necessário uma pessoa para a montagem do produto.



Produto pesado, cuidado!



Evitar contato com objetos cortantes



Não utilizar produtos abrasivos na limpeza



Limpeza com pano úmido, secar logo em seguida

PARTES:

- Ⓟ P1 Barra Frontal Auxiliar
- Ⓟ P2 Barra Traseira Auxiliar
- Ⓟ P3 Estrado **x3**
- Ⓟ P4 Travessa inferior do Estrado **x3**

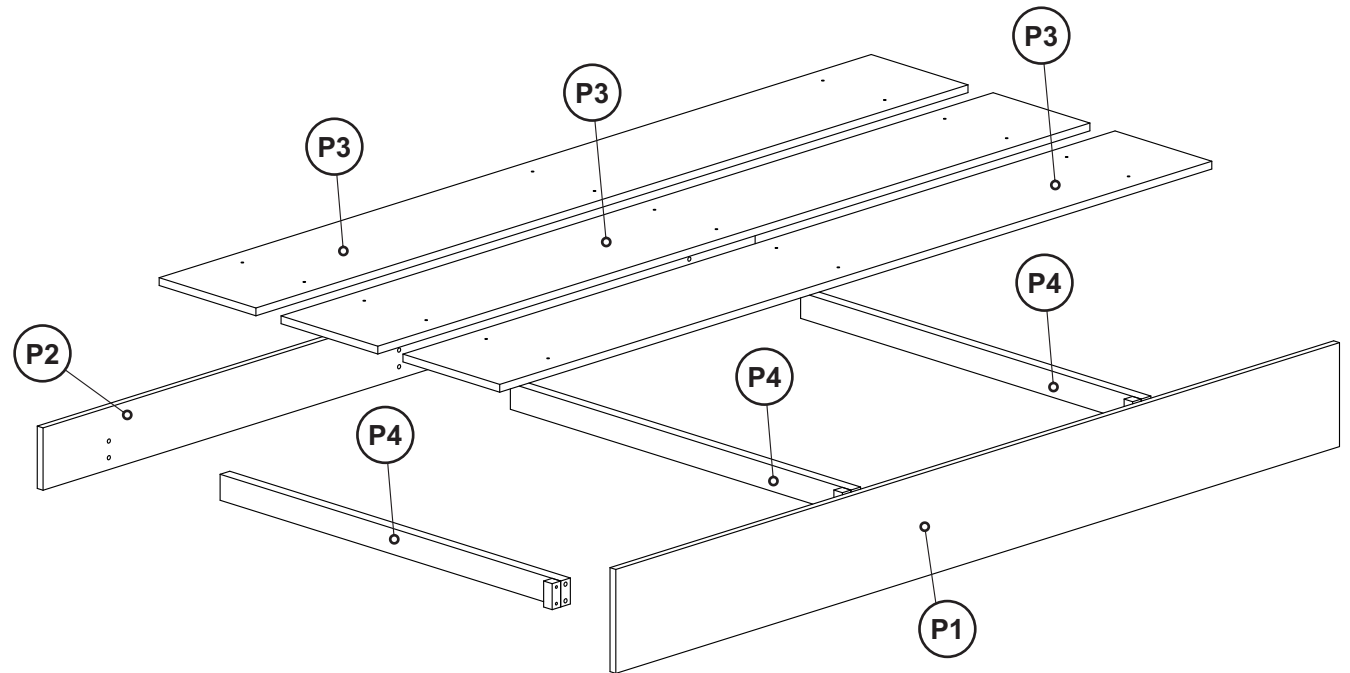

Confira se todos os componentes e partes do seu móvel estão corretos, **antes de iniciar a montagem.**

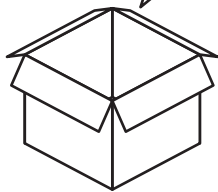

COMPONENTES:

A

Cavilha 8 x 30 x 9 

B

Par. 3,5 x 30mm CH x 24 

C

Par. 3,5 x 16mm PN x 12 

D

Chave Allen Zeta 4mm x 1 

E

Sache de Cola x 1 

F

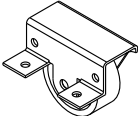
Rodizio x 3 

G

Par. 7,0 x 50mm cab 17 x 3 

H

Sapata de Madeira (140 x 25 x 18mm) x 3 

I

Par. 3,5 x 45mm CH x 6 

Confira se todos os componentes e partes do seu móvel estão corretos, antes de iniciar a montagem.

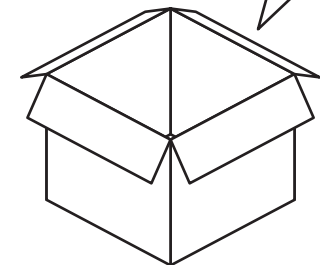

MONTAGEM:

- 1.** Colocar um pouco de cola nos furos e inserir as cavilhas nas peças **(4)**.

(A)

Cavilha 8 x 30 x 9

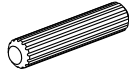

(E)

Sache de Cola x 1

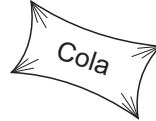

(C)

Par. 3,5 x 16mm PN x 12



(F)

Rodizio x 3

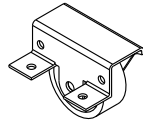

(H)

Sapata de Madeira (140 x 25 x 18mm) x 3

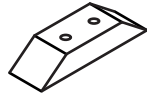

(I)

Par. 3,5 x 45mm CH x 6

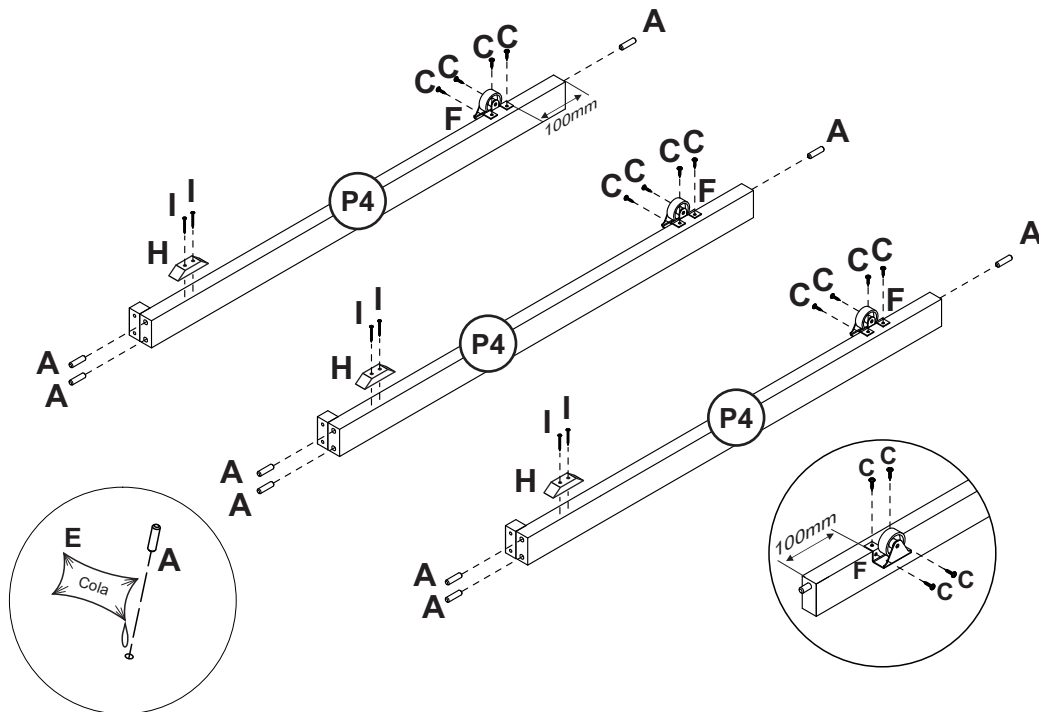

- 2.** Fixar as peças **(4)** na peça **(1)** utilizando os parafusos **B**.

(B)

Par. 3,5 x 30mm CH x 6

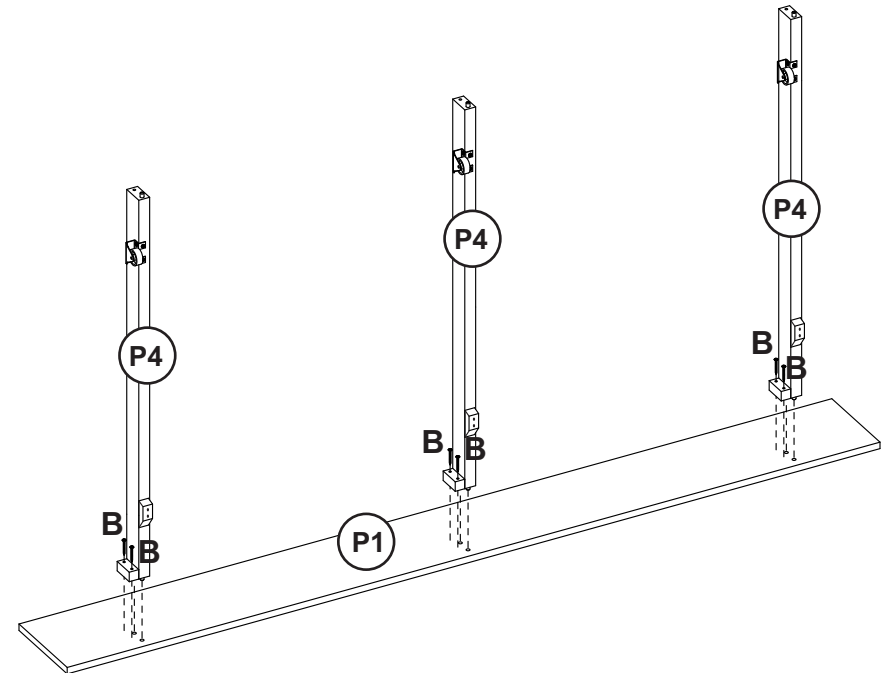

3. Encaixar a peça (2) nas peças (4) e fixar utilizando os parafusos G.

(D)
Chave Allen Zeta 4mm x 1 

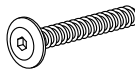
(G)
Par. 7,0 x 50mm cab 17 x 4 

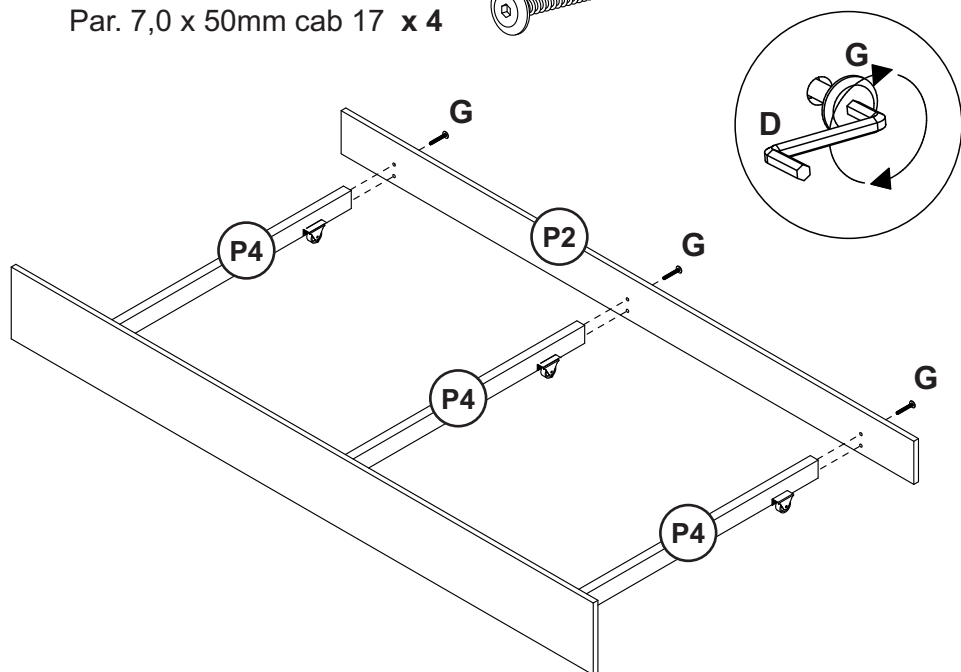

4. Fixar as peças (3) utilizando os parafusos B.

(B)
Par. 3,5 x 30mm CH x 18 